

VAV Adjustable Thermal Diffuser (SFPV - Steel) (SHPV - Aluminum)

The Carnes is an aesthetically pleasing and economical alternative to a full VAV system. This diffuser offers easy installation and requires no electrical or pneumatic connections. Because of this, the SFPV/SHPV has virtually no operating costs. The SFPV/SHPV offers VAV control to smaller areas within a larger open space.

The Carnes SFPV/SHPV is a thermally powered variable air volume diffuser. Each diffuser offers self contained and self powered VAV room temperature control in a nominal 24" x 24" (610 x 610) diffuser.

The SFPV/SHPV varies supply air volume to provide both VAV heating and VAV cooling. The diffusers are thermally powered using two room temperature sensing elements and two supply air sensing elements. The room temperature settings are separately adjustable.

Here are just a few benefits of the SFPV/SHPV:

- The SFPV/SHPV is self contained. No electrical or pneumatic connections are required.
- Low cost installation and operation.
- Separate set points for VAV cooling and heating.
- Easily removable plaque face to adjust set points.
- Circular cone shaped damper provides maximum Coanda effect and avoids dumping. 1/8" foam padding added for quiet operation.

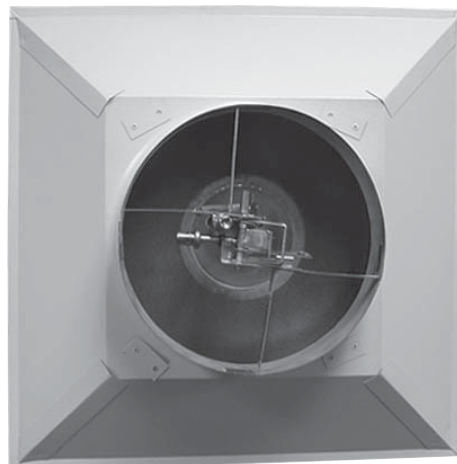
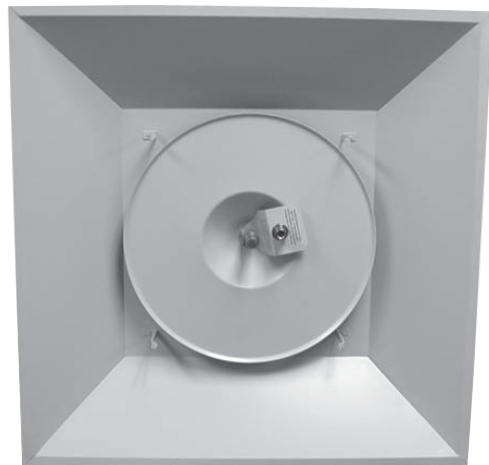
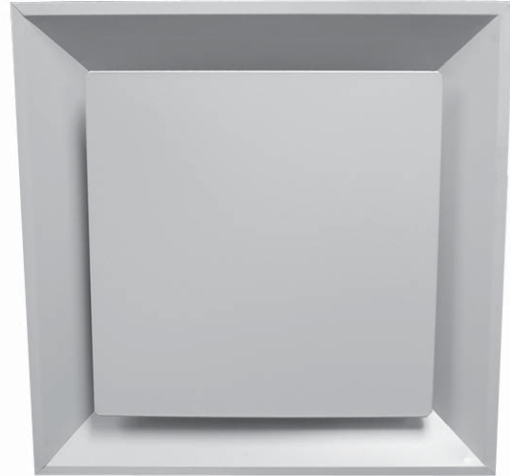

Application

The SFPV/SHPV is a thermally powered VAV diffuser which is completely self-contained and self-powered. The mechanism is operated by four thermostatic elements to provide VAV room temperature control in heating and cooling. The simple design is based on fewer moving parts to hinder the element's response. A cone shaped diffusion damper creating less turbulence allows complete and even distribution with 1/8" foam padding for quiet operation.

Standard Features

- 24 gauge electro-galvanized construction.
- Heating and cooling modes.
- Self-contained, thermally actuated VAV control.
- Standard finish is electrocoat baked enamel.
- Standard color is Carnes #11 bright white.
- Available in 6", 8", 10", or 12" inlet.
- Easy installation. The SFPV/SHPV is self contained with no external wiring required.
- Ribbed inlet for easy installation to flex duct.
- Other models available as specials (contact factory).

Accessories

- KXFAA auxiliary frame (p. A447).
- Relief rings available for all sizes.

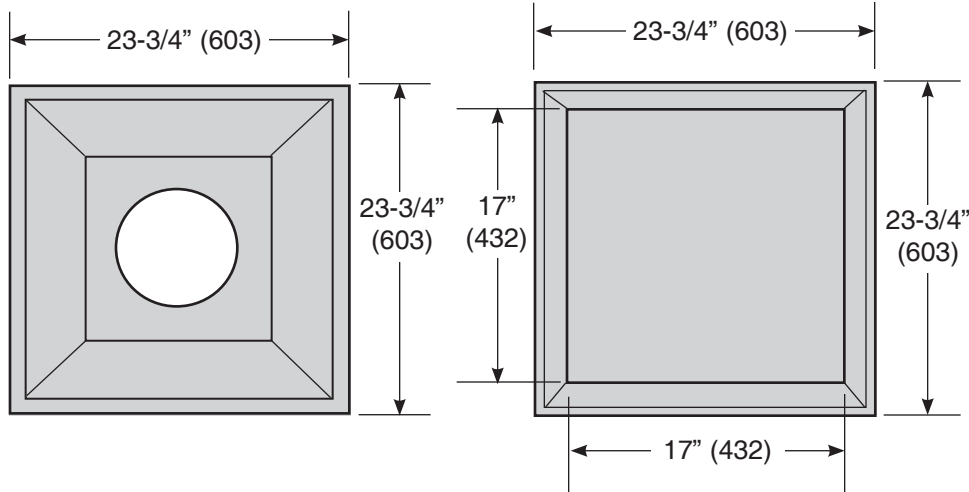
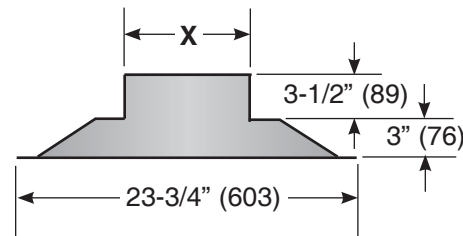
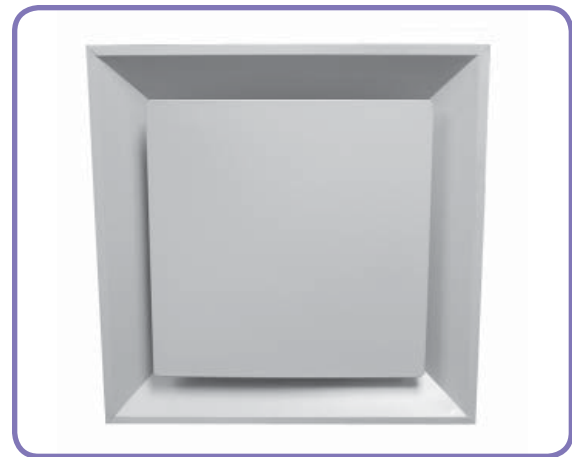

Model Numbering System

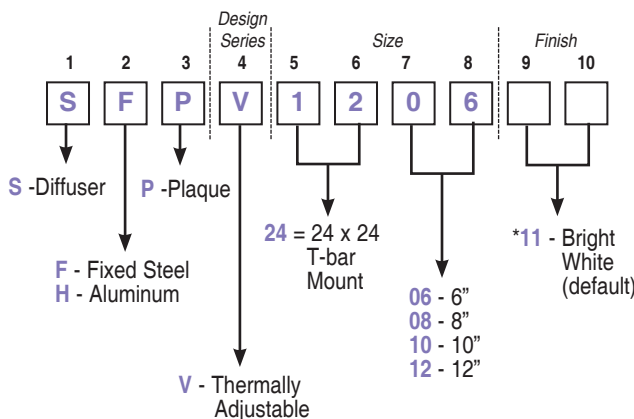

*Other colors available upon request.

Accessories

▼ **Relief Ring**

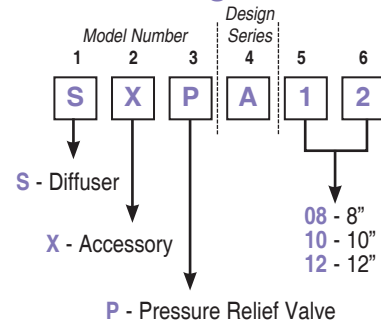

INDUCTION PATH

Room air is induced across elements #3 and by #4 by use of a simple induction wing. This diverts a small amount of supply air which induces a room air sample through an induction trough located on the back side of the appearance panel.

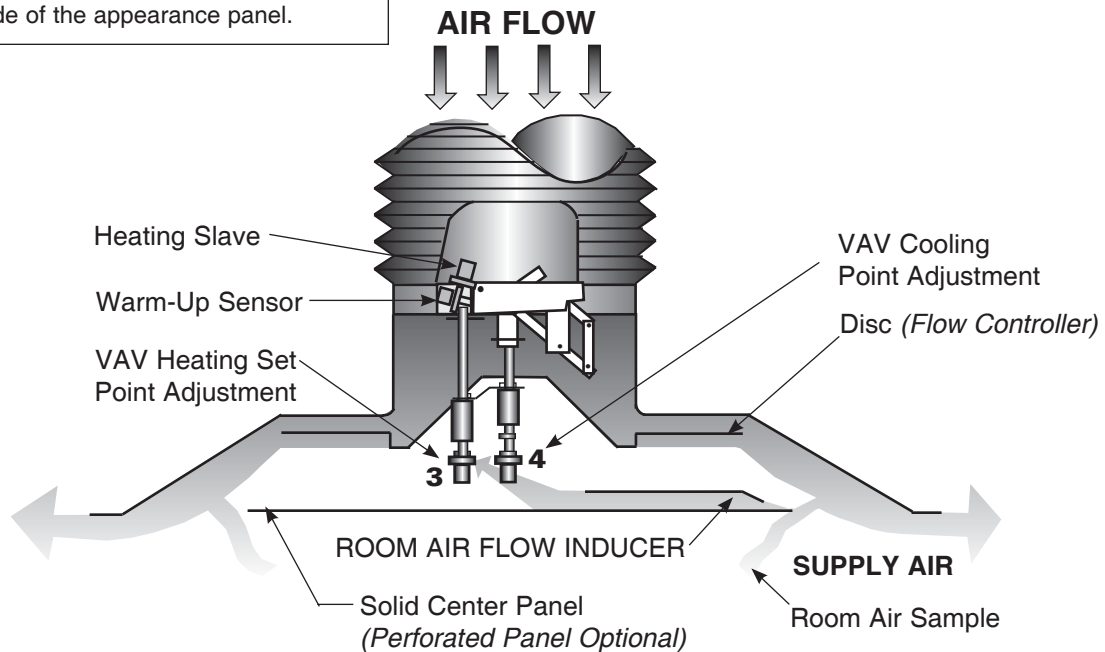

The Model SFPV/SHPV VAV provides room temperature control for heating and cooling. Separately adjustable heating and cooling set-points. Factory room temperature set-points of 74 degrees.

Room air is induced past the thermal elements which sense and adjust air flow based upon space requirements. The elements are mechanical and require no electrical or pneumatic connections.

FEATURES

1. Construction: *SFPV - 24 ga electro-galvanized steel*
SHPV - aluminum
2. Controls: *Self-contained, thermally actuated VAV control.*
3. Models available: *24"x24" (610x610) with 6" (152), 8" (203), 10" (254), 12" (305) neck sizes.*
4. Accessories: *Plaster ceiling frames, spline, fine line, relief adapter rings, baffles, perforated face plate.*
5. Finish: *White powder coat*

24"x 24" (610 x 610) SQUARE DIFFUSER PERFORMANCE

Listed Size	Inlet SP In. W.G.	Max. CFM	Throw @ Maximum CFM			Throw 25% of CFM		NC @ Max. CFM*
			V _t 50	V _t 100	V _t 150	V _t 50	V _t 100	
6"	.05	85	5	3	1	3	1	•
	.10	120	6	3	2	3	2	20
	.15*	150	7	4	2	4	3	24
	.20	170	8	5	3	6	4	28
	.25	220	8	6	5	7	4	33
8"	.05	160	6	4	2	4	2	•
	.10	225	8	5	3	5	3	20
	.15*	275	9	5	4	6	4	25
	.20	320	10	6	5	8	5	29
	.25	355	12	7	6	9	6	33
10"	.05	250	7	4	3	5	3	•
	.10	355	9	5	4	6	4	22
	.15*	450	11	6	5	7	4	26
	.20	500	12	7	6	8	5	29
	.25	580	13	8	7	10	7	32
12"	.05	365	8	5	4	6	4	•
	.10	520	11	7	6	8	5	23
	.15*	650	12	7	6	8	6	27
	.20	740	14	8	7	10	7	32
	.25	820	15	10	9	11	8	38
.30	890	17	11	10	12	9	40	

* Denotes nominal rating

NC based on LW 10 ⁻¹²W — 10 db
 V_t Terminal Velocity in fpm
 • less than NC 20

▼ Suggested Guide Specifications

Thermally powered variable air volume diffuser shall be Carnes Model SFPV/SHPV diffuser. Each unit shall be a self-contained, self-powered VAV room temperature control in a nominal 24"x 24" (610x610mm) diffuser. External wiring or pneumatics shall not be allowed.

The diffuser shall vary supply air volume to provide both VAV heating and VAV cooling. They shall be thermally powered by using two room temperature sensing elements, and two supply air sensing elements. The room temperature settings shall be separately adjustable.

One room sensing element shall sense room temperature and vary the support air when cooling. The other room sensing element shall sense room temperature and vary the supply air when heating.

Each room sensing element shall be factory set at 74 degree set point heating and cooling (approximately 3 turns out from plastic isolator bushing). For more heating, turn element #3 counterclockwise and less heating turn element #3 clockwise. For a cooler room temperature, turn element #4 clockwise. For a warmer room, temperature turn counterclockwise. Determine room temperature set-point by aligning the end of the element with the indicators on the temperature scale. Each full turn, or each indicator will equal plus or minus 2 degrees.

In the heating mode the VAV diffuser shall close on a rise in room temperature and in the cooling mode they shall open on a rise in room temperature. The change over element #2 shall be factory installed and set to engage the cooling mode when supply air temperature rises above 78 degrees F and return to the heating mode when supply air temperature falls below 68 degrees F.

Each unit shall have a circular cone shaped damper to provide maximum Coanda effect and to avoid dumping. Each unit shall have 1/8" (3mm) foam padding for quiet operation.

Each diffuser shall have an appearance panel that can be easily removed from the spring clips to allow adjustment of room temperature set points. Instructions for the diffuser shall be on the back side of the appearance panel.

The manufacturer shall warrant the diffuser for **10 years**. The diffuser shall be free from defects in material and workmanship.