

IP [English] Dimensions
Metric (SI) In Parentheses

Air Specialties Express, 448 S. Main St., P. O. Box 930040, Verona, WI 53593-0040 Phone: (877)945-9175 Fax: (608)845-6504 www.airspecialties.com

Multi-Panel In-line Construction

Notes:

1. Maximum single panel width and height is 48" listed size, regardless of blade alignment.
2. Panels are made in even inch increments unless specified otherwise.
3. Front blade alignment is as pictured.
4. Grille height & shown are listed size dimensions.
5. Panel flanges are sheared and aligned with joining strips.

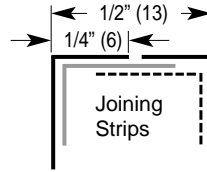

- Height: 50-96"
- Width: Up to 48"
- Two Sections
- Any blade alignment
- Height: Over 96"
- Width: Up to 48"
- Three or More Sections
- Any blade alignment

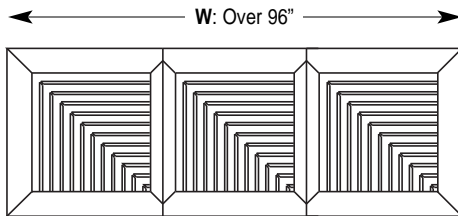

- Height: Up to 48"
- Width: Over 96"
- Three or more sections.
- Any blade alignment.

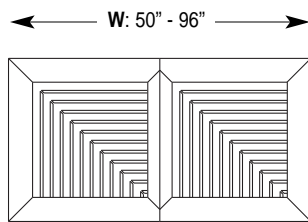
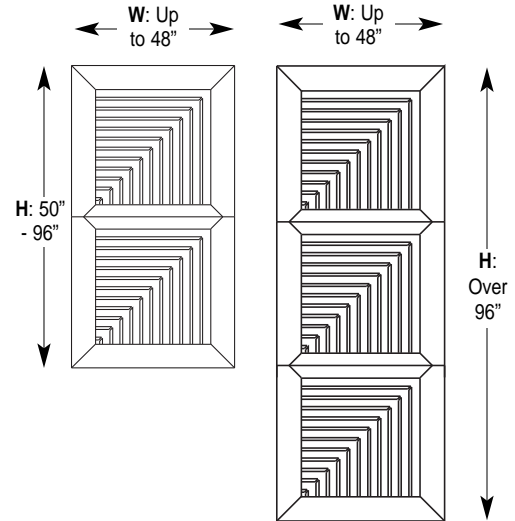

- Height: Up to 48"
- Width: 50" to 96"
- Two sections.
- Any blade alignment.

Multi-Panel Ganged Construction

Notes:

- Maximum single panel width and height are 48" listed size.
- Panels will be made in even inch increments unless specified otherwise.
- Front blade alignment is always parallel to center support.
- Either the vertical or horizontal joint can be sheared down, but not both.
- The center support can be aligned vertically or horizontally, depending on blade alignment desired. It is shown here mounted horizontally.
- Grille dimensions shown are listed dimensions. Other dimensions are actual.

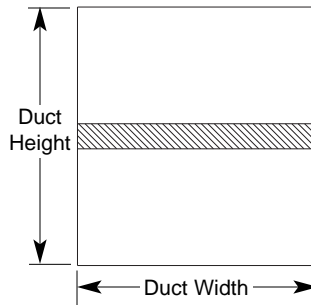

Center Support Attachment to Wall Opening

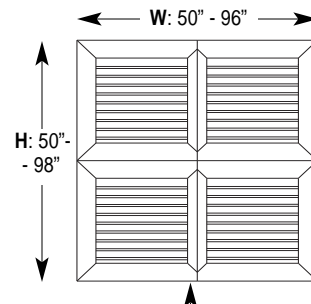
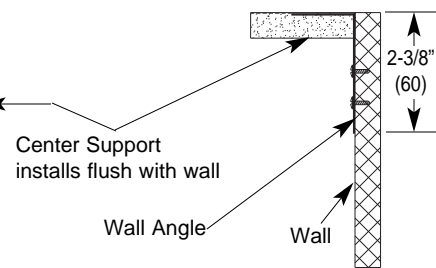

Cross-Sectional View of Center Support with Grilles Attached

