

**STEEL REGISTER & GRILLE MULTI-PANEL CONSTRUCTION
FOR LOUVERED FACE RETURN and
PERFORATED FACE RETURN MODELS**

IP [English] Dimensions
Dimensions given in Inches

Air Specialties Express, 448 S. Main St., P. O. Box 930040, Verona, WI 53593-0040 Phone: (877)945-9175 Fax: (608)845-6504 www.airspecialties.com

Multi-Panel In-line Construction

Notes:

1. Panels will be made in even inch increments unless specified otherwise.
2. Dimensions shown are listed size dimensions.
3. Max. blade length on louvered face models is nominal 48".
4. Panels are sheared and aligned with joining strips.

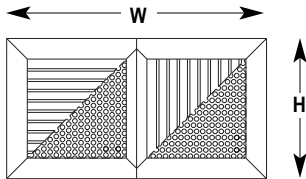

- Height: Up to 36"
- Width: 50" to 96"
- Horizontal Blade Alignment
- Two Sections

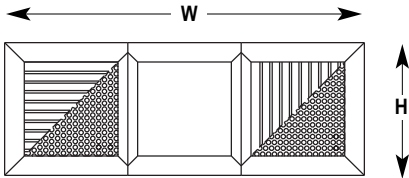

- Height: Up to 36"
- Width: Over 96"
- Horizontal Blade Alignment
- Three or More Sections

- Height: 38-72"
- Width: Up to 48"
- Horizontal Blade Alignment
- Two Sections

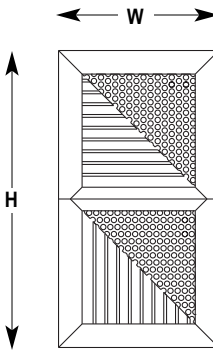

- Height: 50-96"
- Width: Up to 36"
- Vertical Blade Alignment
- Two Sections

- Height: Over 72"
- Width: Up to 48"
- Horizontal Blade Alignment
- Three or More Sections

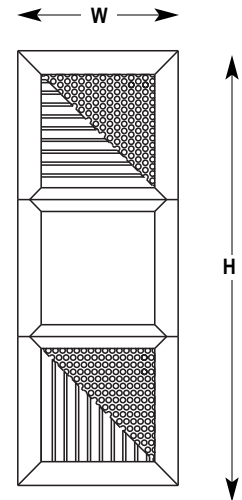

- Height: Over 96"
- Width: Up to 36"
- Vertical Blade Alignment
- Three or more Sections

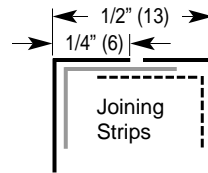

Multi-Panel Ganged Construction

Notes:

1. Either the vertical or horizontal joint can be sheared down, but not both.
2. Maximum single panel width is 48" listed size.
3. Maximum blade length on louvered face models is listed size 48".
4. Maximum single panel height is 36" listed size.
5. Panels are made in even inch increments unless specified otherwise.
6. Blade alignment is always parallel to center support.
7. The center support can be aligned vertically or horizontally, depending on the blade alignment desired. It is shown here mounted horizontally.
8. Grille dimensions shown are listed size dimensions.

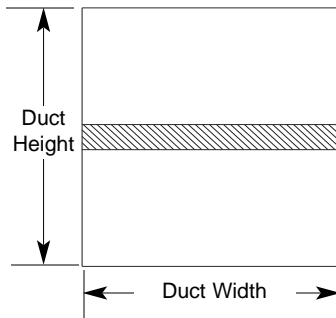

Center Support Attachment to Wall Opening

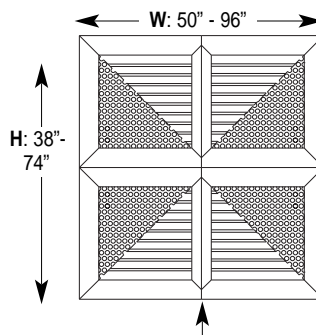
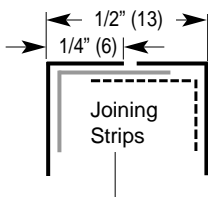
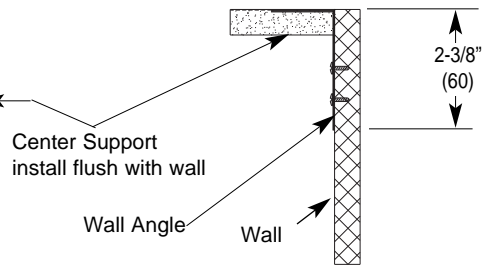

Cross-Sectional View of Center Support with Grilles Attached

