

Imperial [IP] Dimensions  
Metric (SI) in Parentheses

CARNES COMPANY 448 S. Main St., P. O. Box 930040, Verona, WI 53593-0040 Phone: (608)845-6411 Fax: (608)845-6504 www.carnes.com

#### SQUARE

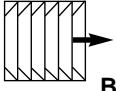

**BLOW-10**

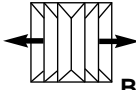

**BLOW-20**

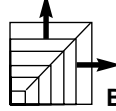

**BLOW-25**

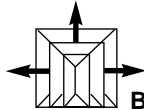

**BLOW-30**

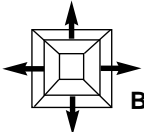

**BLOW-40**

#### RECTANGULAR



**BLOW-11**

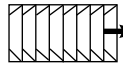

**BLOW-12**

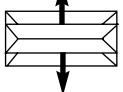

**BLOW-21**



**BLOW-22**

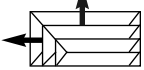

**BLOW-26**

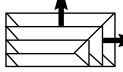

**BLOW-27**

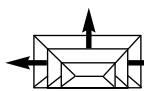

**BLOW-31**

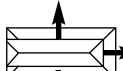

**BLOW-32**



**BLOW-41**

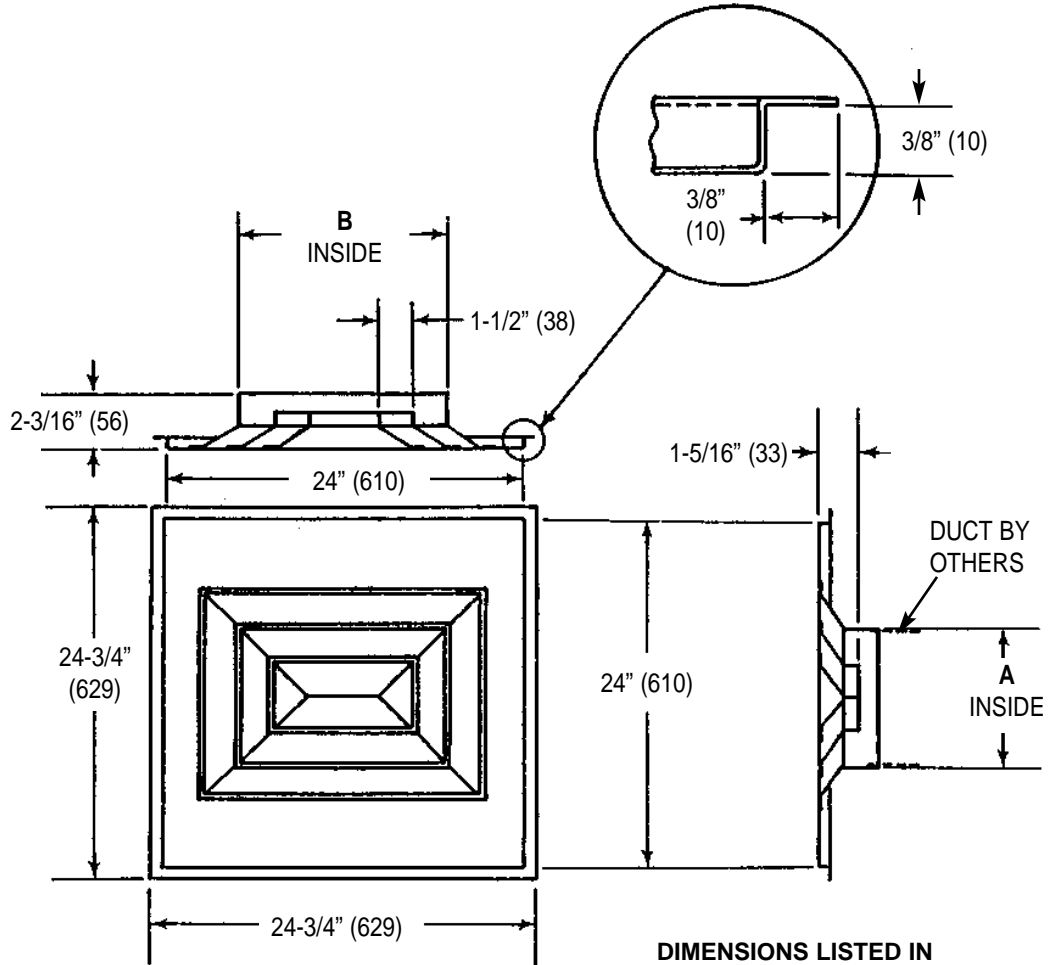

#### ADJUSTMENT DETAIL

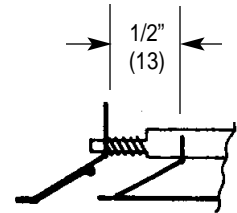

Two spring-loaded pins, four-pin suspension to ceiling plate. Removable and interchangeable center core assembly.

**Note:** 1 - Standard Finish #11 White Electrocoat.

#### DIMENSIONS LISTED IN INCHES (Millimeters)

Size A x B	Size A x B
6x6 (152x152)	12x18 (305x457)
6x9 (152x229)	12x21 (305x533)
6x12 (152x305)	15x15 (381x381)
6x15 (152x381)	15x18 (381x533)
6x18 (152x457)	15x21 (381x533)
6x21 (152x533)	18x18 (457x457)
9x9 (229x229)	18x21 (457x533)
9x12 (229x305)	21x21 (533x533)
9x15 (229x381)	21x24 (533x610)
9x18 (229x457)	24x24 (610x610)
9x21 (229x533)	36x36 (914x914)
12x12 (305x305)	36x48 (914x1219)
12x15 (305x381)	48x48 (1219x1219)