

Imperial [IP] Dimensions
Metric (SI) in Parentheses

CARNES COMPANY 448 S. Main St., P. O. Box 930040, Verona, WI 53593-0040 Phone: (608)845-6411 Fax: (608)845-6504 www.carnes.com

SQUARE

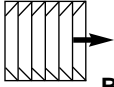

BLOW-10

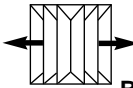

BLOW-20

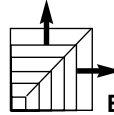

BLOW-25

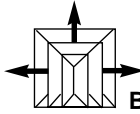

BLOW-30

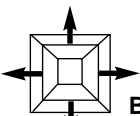

BLOW-40

RECTANGULAR

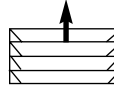

BLOW-11

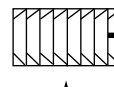

BLOW-12

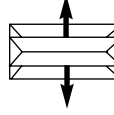

BLOW-21

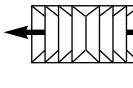

BLOW-22

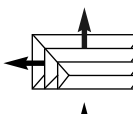

BLOW-26

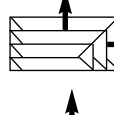

BLOW-27

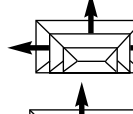

BLOW-31

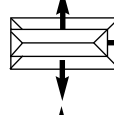

BLOW-32

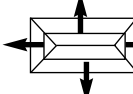

BLOW-41

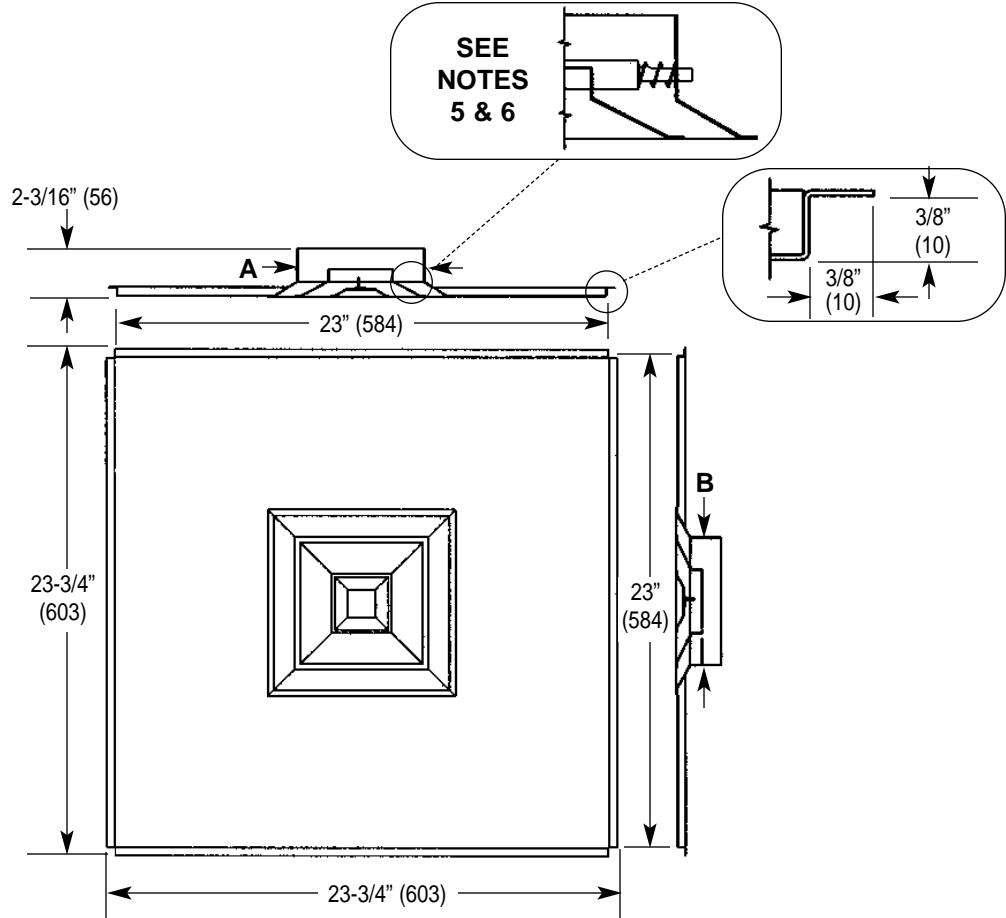

SEE
NOTES
5 & 6

Notes:

1. The standard finish is #11 White Electrocoat baked enamel.
2. The inlet is nominal size plus 1/4" (6) to fit over the duct.
3. The tegular panel is sized for 15/16" (24) T-bar.
4. Panels to fit 9/16" (14) T-bar are available.
5. Core is held in by 4-pin, spring loaded attachment.
6. Cores are removable and interchangeable with other blot patterns of the same size and shape.

DIMENSIONS LISTED IN INCHES (Millimeters)

Nominal Neck Size		
A x B	A x B	A x B
6 x 6 (152 x 152)	9 x 9 (229 x 229)	12 x 15 (305 x 381)
6 x 9 (152 x 229)	9 x 12 (229 x 305)	12 x 18 (305 x 457)
6 x 12 (152 x 305)	9 x 15 (229 x 381)	15 x 15 (381 x 381)
6 x 15 (152 x 381)	9 x 18 (229 x 457)	15 x 18 (381 x 457)
6 x 18 (152 x 457)	12 x 12 (305 x 305)	18 x 18 (457 x 457)