

Imperial [IP] Dimensions
Metric (SI) in Parentheses

CARNES COMPANY 448 S. Main St., P. O. Box 930040, Verona, WI 53593-0040 Phone: (608)845-6411 Fax: (608)845-6504 www.carnes.com

SQUARE

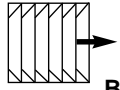

BLOW-10

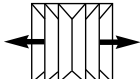

BLOW-20

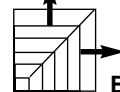

BLOW-25

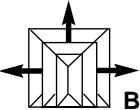

BLOW-30

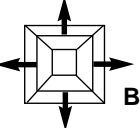

BLOW-40

RECTANGULAR

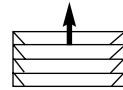

BLOW-11

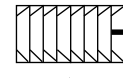

BLOW-12

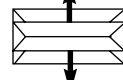

BLOW-21



BLOW-22

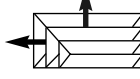

BLOW-26

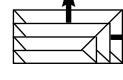

BLOW-27

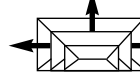

BLOW-31

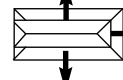

BLOW-32

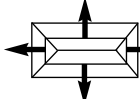

BLOW-41

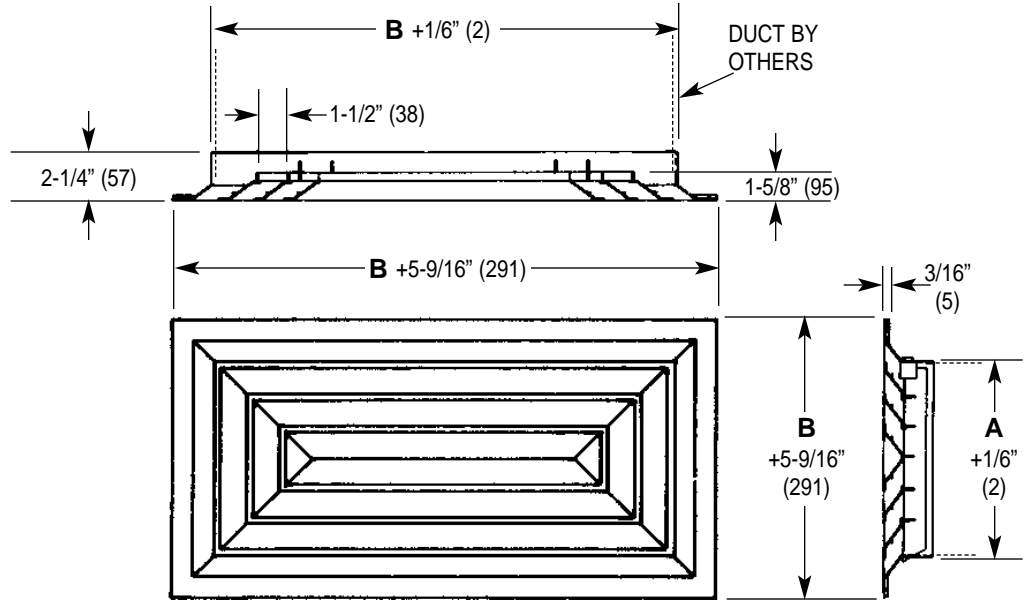

MINIMUM CEILING OPENING = $A + 2''$ (51) x $B + 2''$ (51)

DIMENSIONS LISTED IN INCHES (Millimeters)

Size A x B	Size A x B
6x6 (152x152)	12x15 (305x381)
6x9 (152x229)	12x18 (305x457)
6x12 (152x305)	12x21 (305x533)
6x15 (152x381)	15x15 (381x381)
6x18 (152x457)	15x18 (381x533)
6x21 (152x533)	15x21 (381x533)
9x9 (229x229)	18x18 (457x457)
9x12 (229x305)	18x21 (457x533)
9x15 (229x381)	21x21 (533x533)
9x18 (229x457)	21x24 (533x610)
9x21 (229x533)	24x24 (610x610)
12x12 (305x305)	

Note: Standard finish #24 etch and lacquer.
#01 white is optional